

DC-833s

User manual



 **AGFAPHOTO**

Thank you for purchasing this AgfaPhoto digital camera. Please read these operating instructions carefully in order to use the digital camera correctly. Keep the instructions in a safe place after reading so that you can refer to them later.

Precautions

- Do not aim the camera directly into the sun or other intense light sources which could damage your eyesight.
- Do not try to open the case of the camera or attempt to modify this camera in any way. High-voltage internal components create the risk of electric shock when exposed. Maintenance and repairs should be carried out only by authorized service providers.
- Do not press the flash too close to the eyes of animals or young children. Eye damage may result. Please remain at least one meter away from infants when using flash.
- Keep the camera away from water and other liquids. Do not use the camera with wet hands. Never use the camera in the rain or snow. Moisture creates internal danger and may cause electric shock.
- Keep the camera and its accessories out of the reach of children and animals to prevent accidents or damage to the camera.
- If you notice smoke or a strange odor coming from the camera, turn the power off immediately. Take the camera to the nearest authorized service center for repair. Never attempt to repair the camera on your own.

Use only the recommended power accessories. Use of power sources not expressly recommended for this equipment may lead to overheating, distortion of the equipment, fire, electrical shock or other hazards.

Disclaimer

We assume no responsibility over and above the provisions of the Product Liability Law for damages suffered by the user or third parties as a result of inappropriate handling of the product or its accessories, or by their operational failure and by their use. We reserve the right to make changes to this product and its accessories without prior notice.

Warning!

Never disconnect to open the camera or remove any parts of it. This will invalidate all guarantee claims.

Using your batteries

For best performance and prolonged battery life, we recommend the use of AA lithium or rechargeable Ni-MH batteries.

Extending battery life

The following functions use up a great deal of battery power and should therefore only be used occasionally:

- Excessive use of flash
- Editing images on the camera display

The battery life can be affected by soiling. Please clean the contacts with a clean and dry cloth before putting the batteries in the camera. Battery performance drops at temperatures below 5° C (41° F). If you use the camera at low temperatures you should have replacement batteries to hand and ensure they do not get too cold. Please note: you should not dispose of cold and seemingly flat batteries because these batteries may work again at room temperature.

Contents

PRECAUTIONS	I		
DISCLAIMER	I	BASIC RECORDING	20
USING YOUR BATTERIES	II		
EXTENDING BATTERY LIFE	II	RECORDING STILL IMAGES	20
GETTING STARTED	1	USING THE Q MODE	21
		SETTING IMAGE SIZE AND QUALITY	22
USING THIS MENU	1	USING THE ZOOM FUNCTION	23
SCOPE OF DELIVERY	2	USING THE FLASH	24
PARTS OF THE CAMERA	3	USING THE MACRO	25
INSERTING THE BATTERIES	5	USING THE SELF-TIMER & BURST	26
LOW BATTERY INDICATOR	5	USING THE APERTURE PRIORITY	27
ABOUT BATTERY TYPE	5	USING THE SHUTTER PRIORITY	27
INSERTING THE MEMORY CARD	6	USING THE MANUAL EXPOSURE	28
ABOUT CAMERA MEMORY	6	RECORDING MOVIE CLIPS	29
DCF PROTOCOL	6	SETTING THE MOVIE SIZE	29
SETTING THE DISPLAY LANGUAGE / DATE &		RECORDING AUDIO CLIPS	30
TIME	7	PLAYING BACK AUDIO CLIPS	30
SETTING THE DISPLAY LANGUAGE	7	RECORDING A VOICE MEMO	31
SETTING THE DATE & TIME	7	PLAYING BACK A VOICE MEMO	31
USING THE LCD MONITOR	9	OTHER RECORDING FUNCTIONS	32
REC MODE	9		
PLAYBACK MODE	10	SETTING THE METERING	32
CHANGING THE LCD STATUS	11	SETTING THE WHITE BALANCE	32
BASIC OPERATION	12	SETTING THE ISO	33
		SETTING THE EXPOSURE	33
TURNING THE POWER ON AND OFF	12	SETTING THE AEB	33
POWER SAVING FUNCTION	12	SETTING THE HIGHLIGHT	33
CHANGING THE MODE	13	SETTING THE SHARPNESS	34
SWITCHING BETWEEN REC MODE AND		SETTING THE PHOTO EDIT	34
PLAYBACK MODE	13	SETTING DATE STAMP	34
SELECTING THE REC MODE	13	SETTING STABILIZER	35
SELECTING THE ASM MODE	14	SETTING FACE TRACKING	35
USING THE MENUS	15	SETTING PHOTO FRAME	35
REC MENU	15	PLAYBACK	36
SETUP MENU	17		
SETUP MENU LIST	18	PLAYING BACK IMAGES	36
		PLAYING BACK MOVIE CLIPS	36

MAGNIFYING & TRIMMING STILL IMAGES		FCC COMPLIANCE AND ADVISORY	60
	37	DECLARATION OF CONFORMITY	61
VIEWING IN THUMBNAIL	38		
PLAYING A SLIDE SHOW	38		
DELETING FILES	39		
DELETING A SINGLE FILE	39		
DELETING MULTIPLE FILES	40		
DELETING ALL FILES	40		
PROTECTING A SINGLE FILE	41		
PROTECTING ALL FILES	41		
PROTECTING MULTIPLE FILES	42		
EDITING IMAGES	43		
ROTATING STILL IMAGES	43		
CHANGING THE IMAGE SIZE	43		
CHANGING THE IMAGE WITH EFFECTS	44		
CHOOSING THE IMAGE WITH PHOTO			
FRAME	44		
COPYING THE FILES	45		
SETTING THE DPOF	46		
CHOOSING A STARTUP IMAGE	47		
<u>MAKING CONNECTIONS</u>	48		
CONNECTING THE CAMERA TO A TV	48		
CONNECTING THE CAMERA TO A PC	49		
USING THE CARD READER	49		
CONNECTING THE CAMERA TO A			
COMPUTER WITH THE USB CABLE	49		
<u>APPENDIX</u>	50		
ABOUT THE FOLDER & FILE NAME	50		
FOLDER STRUCTURE	50		
FILE NAMING	50		
TROUBLESHOOTING	51		
SPECIFICATIONS	52		
FUNCTION AVAILABLE LIST	53		
CUSTOMER CARE	59		
DISPOSAL OF WASTE EQUIPMENT BY			
USERS IN PRIVATE HOUSEHOLDS IN THE			
EUROPEAN UNION	60		

Getting Started

Using This Menu

Getting Started

This section contains information you should know before using this camera.

Basic Operation

This section explains all recording features of this camera.

Basic Recording

This section explains how to record still images, movies, and audio files.

Other Recording Functions

This section explains common operations about recording images.

Playback

This section explains playback, delete, and edit functions of still images, movies and audio files.



Making Connections

This section tells you how to connect this camera to a computer or TV.

Appendix

This section describes the troubleshooting and the camera specification.

The meanings of the symbols used in this user's manual are explained below:

 Caution	This indicates cautions that should be read before using these functions.
 Tips	This indicates the useful information when using this camera.
	This indicates the reference page.

Scope of delivery

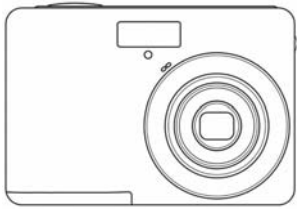

AgfaPhoto DC-833s

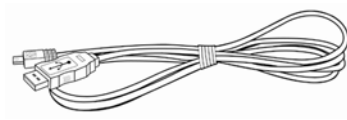

USB Cable

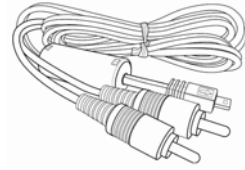

AV Cable

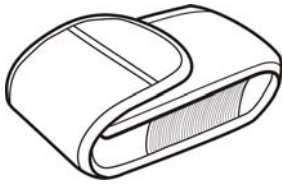

Soft Case



Strap

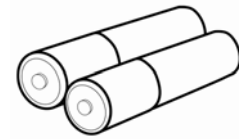

2 x AA Batteries

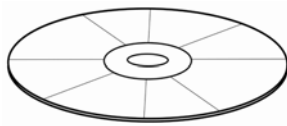

Software Installation
CD-ROM

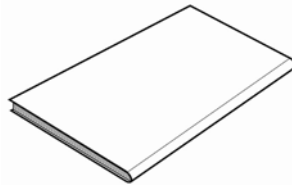

Quick Start Guide

Caution

- Do not swing the camera around by the strap.

Parts of the Camera

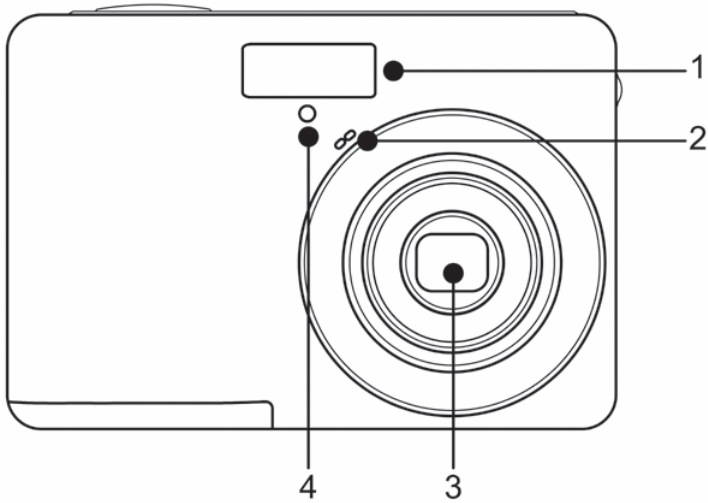

1. Flash (👉 page 24)
2. Microphone
3. Lens
4. Self-timer Lamp

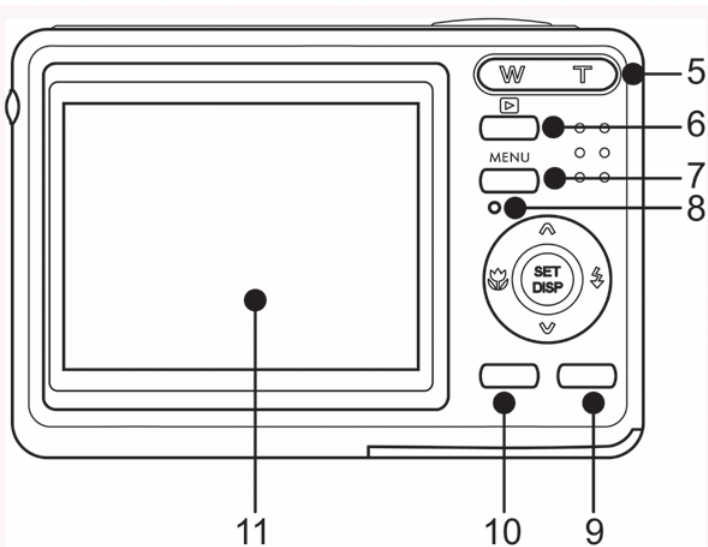

5. Zoom Button (👉 page 23)
 - Thumbnail (👉 page 38)
 - Playback Zoom (👉 page 37)
6. Playback Button (👉 page 13)
7. Menu Button (👉 page 15)
8. Operation Lamp
9. Mode Button (👉 page 13)
10. ASM Button (👉 page 14)
 - Delete Button (👉 page 39)
11. LCD Monitor (👉 page 9)
12. SET/DISP Button (👉 page 11)
13. Flash Button (👉 page 24)
14. Macro Button (👉 page 25)

Four-way Control

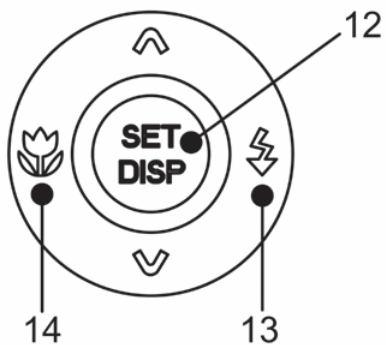

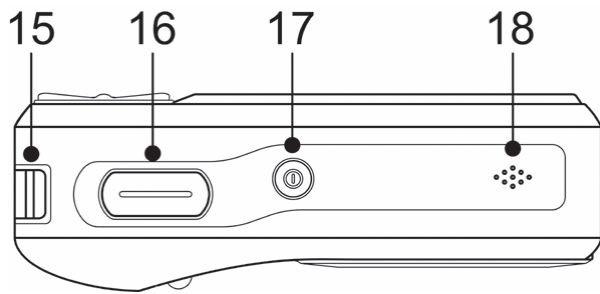

- 15. Strap Ring
- 16. Shutter Button
(☞ page 20, 29)
- 17. Power Button (☞ page 12)
- 18. Speaker

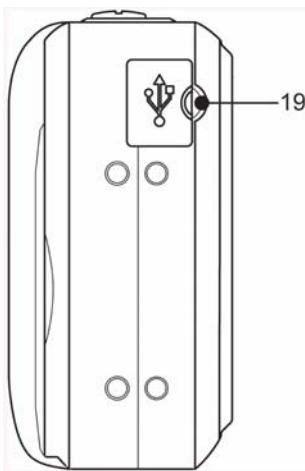

- 19. USB/AV Terminal
(☞ page 19, 49)

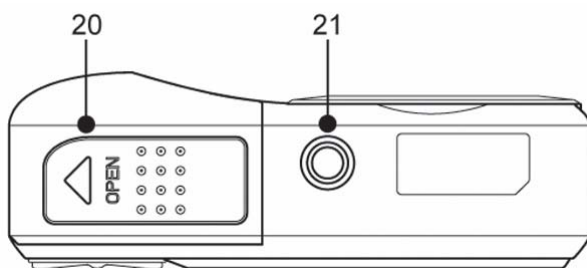

- 20. Battery Cover (☞ page 5)
- 21. Tripod Socket

Inserting the Batteries

1

Open the battery cover.

- Slide the battery cover in the direction indicated by the arrow.

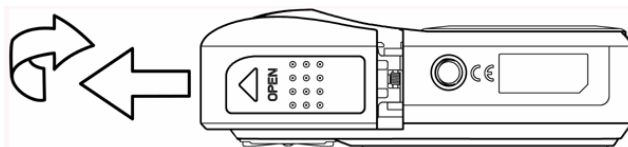

2

Insert the batteries.

- Insert two AA-size batteries with the positive (+) and negative (-) poles matching the directions indicated inside the battery room.

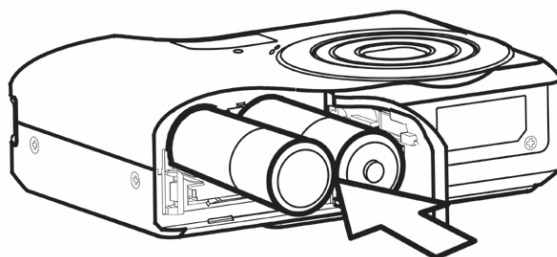

3

Close the battery cover.

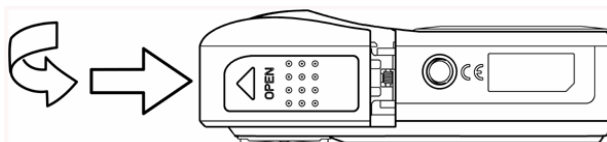

Low Battery Indicator

A low battery indicator  appears on the LCD screen when the batteries are nearly exhausted. Batteries should be replaced promptly when the low battery indicator appears.



Caution

- Risk of explosion if battery is replaced by an incorrect type dispose of used batteries according to the instructions.
- Be sure to turn off the camera power before insert or remove batteries.
- It is recommended to use the provided battery. For other compatible batteries, please refer to Battery types. (👉 page 19). Use of any other type battery is not recommended.
- Replace all batteries at the same time. Never mix old and new batteries.
- Remove batteries if you will not be using them for a long time.
- The camera body may feel warm after extended use. This is normal.

About Battery Type

After replacing the batteries, please check the Battery Type in the setup menu (👉 page 19).

Inserting the Memory Card

You can use SD cards with this digital camera. The memory card slot is located beneath the battery cover, adjacent to the battery compartment.

1

Open the battery cover.

- Slide the battery cover in the direction indicated by the arrow.

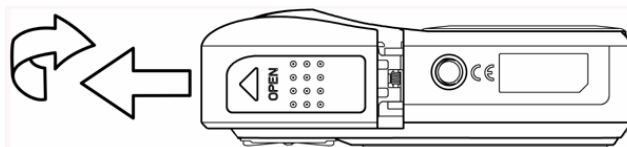

2

Insert the card.

- Insert the card with the label facing up and the arrow pointing in.

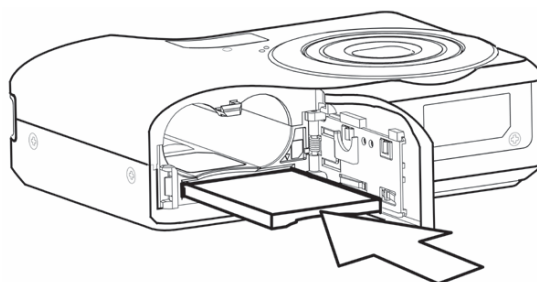

?

Tips

- To remove the card, gently press on the edge of the card and release it. Pull the card out and close the battery cover.

3

Close the battery cover.

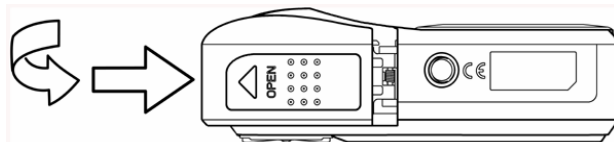

!

Caution

- It may cause damage to the card if removed while the camera is on.
- Do not touch the connection terminals on the back side of the card.

About Camera Memory

This camera is equipped with internal memory. If the memory card is not inserted in the camera, all images and movie clips recorded by the camera will be stored in the internal memory. If the memory card is inserted, images and movie clips are stored on the memory card.

DCF Protocol

The DCF protocol defines the format for image file data as well as the directory structure for the memory card. Images that are taken by a DCF camera can be viewed on DCF-compatible cameras from other manufacturers.

Setting the Display Language / Date & Time

When using the camera for the first time after purchasing, be sure to choose a language and set the date & time before using the camera.

Setting the Display Language

1 Turn the power on, and set the camera to the Setup Menu (☞ page 17).

2 Select [🗨️ Language].

- Press ▲ or ▼ to select [LANGUAGE] then press ▶ or the SET button to launch the submenu.



3 Select a language.

- Press ▲ or ▼ to select a language and press ◀ or the SET button to apply the setting.

4 Press the MENU button to close the menu.

Setting the Date & Time

1 Turn the power on, and set the camera to the Setup Menu (☞ page 17).

2 Select [📅 Date & Time].

- Press ▲ or ▼ to select [Date & Time] then press ▶ or the SET button to launch the submenu.



3 Set date and time.

- Press ▲ or ▼ to change the value of the cursor located. Press ◀ or ▶ to move the cursor between settings.

? Tips

- Holding down ▲ or ▼ changes the values continuously.
- For date stamp setting (☞ page 34).

4

Apply the setting.

- After adjusting the settings, press the **SET** or the **MENU** button to apply the setting.



Caution

- If the batteries are removed for longer than 48 hours, the date and time will need to be re-set.

Using the LCD Monitor

The LCD monitor is used to compose images while recording, adjust settings and replay images. The following indicators may appear on the LCD monitor while recording or playing back images.

REC mode

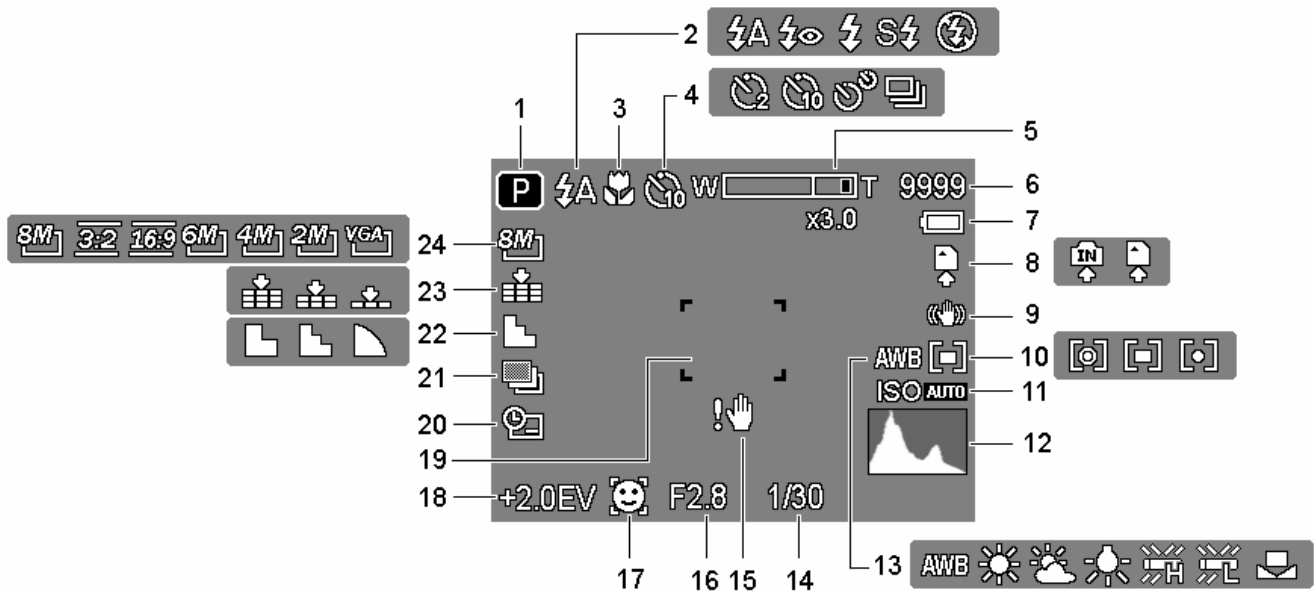

- | | | | |
|----|--------------------------------|----|----------------------------|
| 1 | Recording mode (👉 page 13) | 13 | White balance (👉 page 32) |
| 2 | Flash (👉 page 24) | 14 | Shutter speed (👉 page 20) |
| 3 | Macro (👉 page 25) | 15 | Shake warning (👉 page 20) |
| 4 | Self-timer / Burst (👉 page 26) | 16 | Aperture value (👉 page 20) |
| 5 | Zoom indicator (👉 page 23) | 17 | Face tracking (👉 page 35) |
| 6 | Shots remaining | 18 | Exposure (👉 page 33) |
| 7 | Battery (👉 page 5) | 19 | Focus area (👉 page 20) |
| 8 | Storage media | 20 | Date stamp (👉 page 34) |
| 9 | Stabilizer | 21 | AEB (👉 page 33) |
| 10 | Metering (👉 page 32) | 22 | Sharpness (👉 page 34) |
| 11 | ISO (👉 page 33) | 23 | Quality (👉 page 22) |
| 12 | Histogram | 24 | Resolution (👉 page 22) |

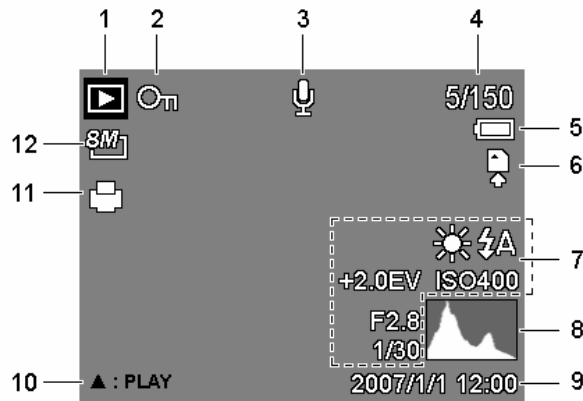

- | | | | |
|---|---------------------------|----|--------------------------------|
| 1 | Playback mode (☞ page 13) | 7 | Recording info (☞ page 11) |
| 2 | Protect (☞ page 41) | 8 | Histogram |
| 3 | Voice memo (☞ page 31) | 9 | Captured date & time |
| 4 | File number / Total | 10 | Voice memo control (☞ page 31) |
| 5 | Battery (☞ page 5) | 11 | DPOF (☞ page 46) |
| 6 | Storage media | 12 | Resolution (☞ page 22) |

! Caution

- Some information may not display correctly if you display images captured by other camera model.

Changing the LCD Status

Press the **SET/DISP** button changes the LCD status as shown below:

■ REC mode



(A) OSD on

(B) Full OSD

(C) Guide line

(D) OSD off



Tips

- Use the “Guide line” to compose images easily before shooting images.

■ PLAYBACK mode

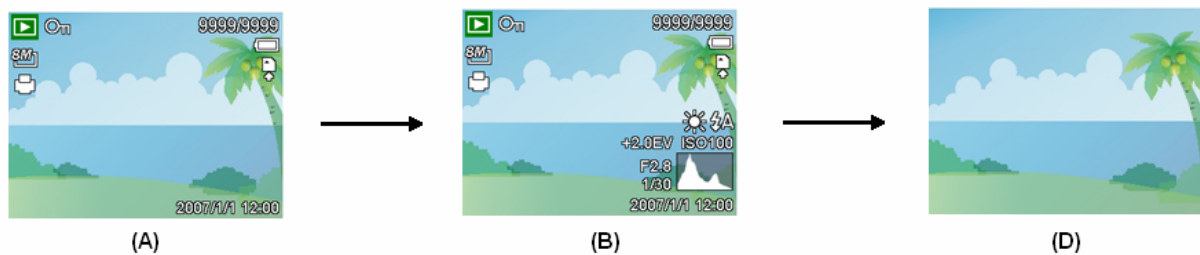

(A) OSD on

(B) Full OSD

(D) OSD off



Caution

- You cannot change the LCD status in the following situation:
 - Manual exposure
 - Recording movie clips or audio files
 - Playing movie clips or audio files
 - Playing the slideshow
 - Viewing in thumbnail
 - Trimming a still image

Basic Operation

Turning the Power On and Off

1 Press the **POWER** button (❶) to turn on the camera in the **REC** mode.

- The power turns on, the lens extends and the LED lights in green.

Press the **PLAYBACK** button (❷) to turn on the camera in the **PLAYBACK** mode.

- The power turns on, and an image displays on the LCD monitor (❸).

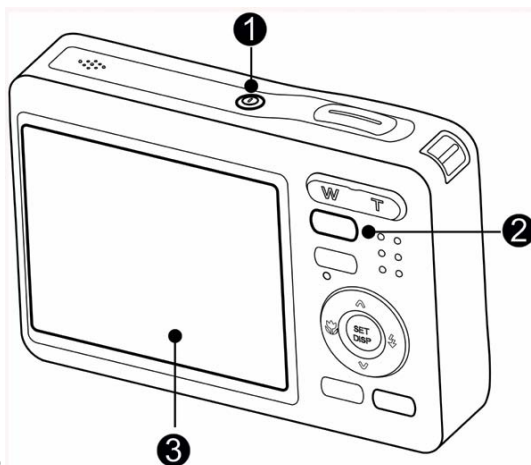

2 Press the **POWER** button (❶) again to turn the power off.

- The power turns off, the lens retracts and the LED turns off.

? Tips

- You can turn on the camera without the start-up and operating sound by pressing and holding the **POWER** (❶) or the **PLAYBACK** (❷) button over 1.5 seconds.
- Switch between REC mode and PLAYBACK mode (👉 page 13).

Power Saving Function

For saving the battery power, the LCD monitor automatically turns off 1 minute after the last control accessed (factory-preset setting). Press any button other than the power button to turn on the LCD monitor. You can change the power save setting in Setup menu (👉 page 18).

After the power saving function has been active for 1 minute, the power will turn off completely. Press the **POWER** (❶) or the **PLAYBACK** (❷) button to restore the power.

The power save feature will not activate in the following situation:

- Recording movie clips or audio files
- Playing movie clips or audio files
- Playing a slideshow
- Connecting the camera to a computer or printer with the USB cable

Changing the Mode

You can record images and voices in the REC mode and use the PLAYBACK mode to replay, delete, or edit images on the LCD monitor.

Switching between REC mode and PLAYBACK mode

In REC mode, press the **PLAYBACK** button (❶) to switch to the PLAY mode.

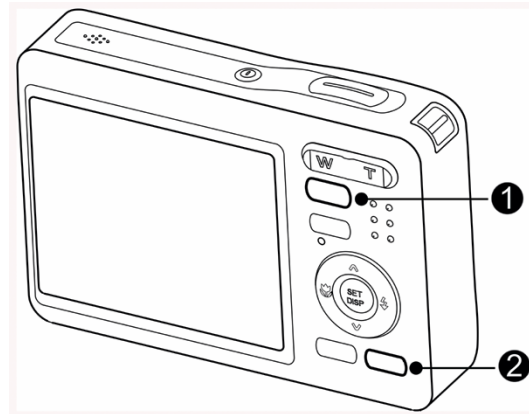

In PLAY mode, press the **PLAYBACK** (❶) or the **MODE** (❷) button to switch to the REC mode.

Selecting the REC mode

1 Set the camera to the REC mode (👉 page 13).

2 Launch the mode palette.







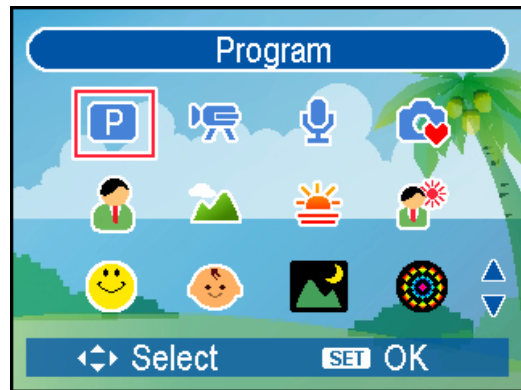



- Press the **MODE** button (❷) to show the scene mode palette.

3 Select a mode.

- Use the four-way control to select a desired mode and press the **SET** button to confirm the setting.



Display	Title	Description
	Program	The camera makes settings suitable for the shooting conditions.
	Movie	For recording movie clips.
	Voice REC	For recording audio.
	Q Mode	Allows beginners to take pictures easily.
	Portrait	Blurring the background to focus on the subject.

Display	Title	Description
	Landscape	Used for the wide scenic views.
	Sunset	Enhance the red hue for recording sunset images.
	Backlight	Shooting the image of backlight object by changing metering.
	Smile Capture	Capture the most brilliant smile of characters.
	Kids	Take a still image to capture moving kids.
	Night Scene	Shooting the subject while keeping the background night scenery.
	Fireworks	Slow shutter speed to take fireworks exploding.
	Snow	Used for the beach or snow scenes.
	Food	Higher saturation makes food more appetizing.
	Building	Enhance the edges of the subject.
	Text	Enhance the black & white contrast.

Selecting the ASM mode

1

Set the camera to the REC mode (👉 page 13).

- It cannot be switch to ASM mode while in Movie or Voice REC mode.

2

Launch the ASM mode.

- Press the **ASM** button (❶) to toggle between Aperture Priority, Shutter Priority, Manual Exposure mode.
- For detail operation (👉 page 26).

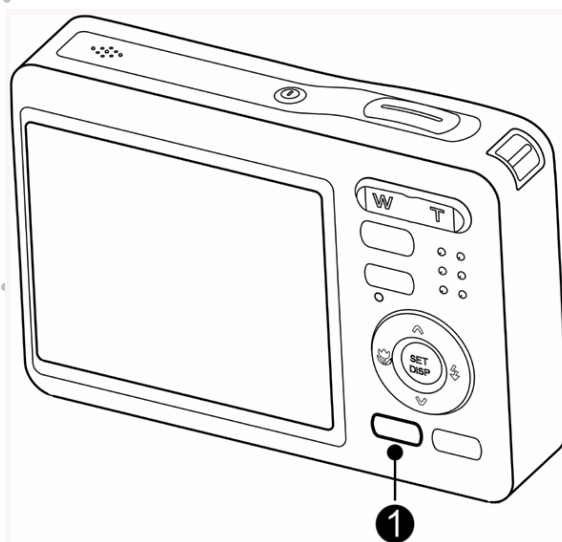

Using the Menu

When a menu is displayed, the four-way control and the **SET** button are used to make the desired settings.

REC menu

1 Turn the power on, and set the camera to the REC mode (page 13).

2 Open the REC menu.

- Press the **MENU** button (1) to display the menu.

3 Select an item.

- Press ◀ or ▶ (2) to select a menu item.

4 Change the setting.

- Press ▲ or ▼ (2) to change the setting.

5 Press the **MENU** (1) or the **SET** (2) button to save the settings and close the menu.

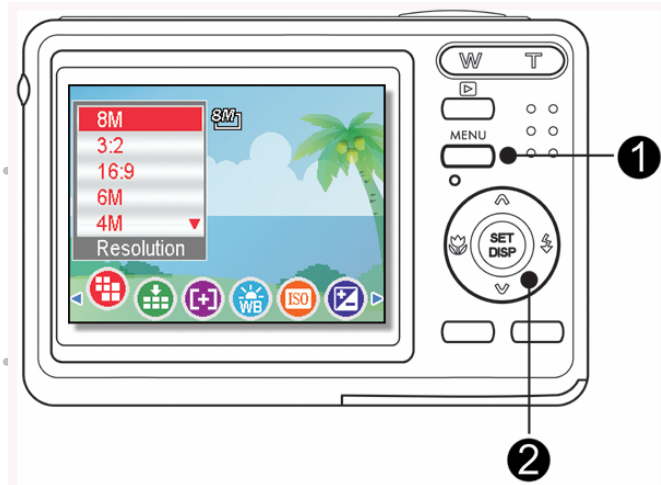

REC menu list (Still Image)

Menu Item	Available Setting	Page
Resolution	8M / 3:2 / 16:9 / 6M / 4M / 2M / VGA	22
Quality	High / Medium / Low	22
Metering	Spot / Center / Multi	32
White Balance	Auto / Daylight / Cloudy / Tungsten / Fluorescent / Custom	32
ISO	Auto / ISO 50 / ISO 100 / ISO 200 / ISO 400 / ISO 800 / ISO 1600	33
Exposure	-2.0EV ... +2.0EV	33
Drive Mode	Off / 2 / 10 / Self / Bulb	26
AEB	Off / On	33
Highlight	Off / Off / On / On	33

Sharpness		34
Effect	Off / B&W / Sepia / Negative / Red / Green / Blue	34
Date Stamp	Off / Date / Date & Time	34
Stabilizer	Off / On	35
Face Tracking	Off / On	35
Photo Frame	Off / Frame 1 ~ 10	35
Digital Zoom	Off / On	23

REC menu list (Movie)

Menu Item	Available Setting	Page
Movie Size	<u>16:9</u> / <u>640</u> / <u>320</u>	29
Metering		32
White Balance	Auto /	32

Setup menu

1

Turn the power on, and set the camera to the **REC** or **PLAYBACK** mode (page 13).

2

Press the **MENU** button (1) to open the **REC** or **PLAYBACK** menu.

- The menu displays depends on whether you are in the **REC** mode or the **PLAYBACK** mode.

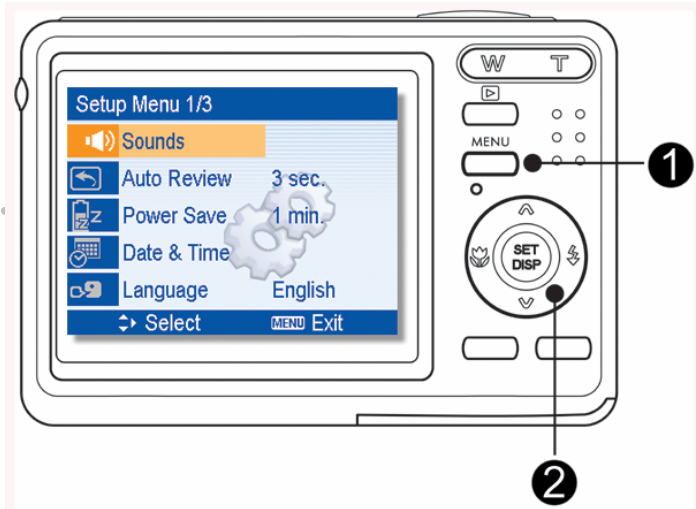

3

Open the **Setup** menu.

- Press four-way control (2) to select **SETUP** () and then press the **SET** () button to display the Setup menu.

4

Select an item.

- Press ▲ or ▼ (2) to select a menu item and then press ► or the **SET** () button to launch the submenu.

5

Change the setting.

- Press ▲ or ▼ (2) to select an option and press ◀ or the **SET** () button to apply the setting.

6

Press the **MENU** (1) button to close the menu.

Menu Item	Functions
	<p>[Series]: Store the latest used file number no matter deleting files or inserting a new memory card.</p> <p>[Reset]: Reset file numbering each time the memory card is changed.</p> <ul style="list-style-type: none"> Resetting the file number is useful for avoiding the file name duplication when images are downloaded to a computer (👉 page 50).
TV Out	<p>You can review images on a television with a supplied AV cable (👉 page 48). TV Out should be set to either NTSC or PAL depending on your region.</p> <p>[NTSC]: America, Japan and others</p> <p>[PAL]: Europe, Oceania and others</p>
USB	<p>[Computer] / [Printer]: Sets the USB mode to connect the camera with a printer or computer (👉 page 49).</p>
S.Image	<p>Sets a recorded image as the start-up image (👉 page 47).</p>
Format	<p>To erase all data stored in the memory card if you are using a card, or all data stored in the internal memory if there is no card inserted.</p> <ul style="list-style-type: none"> A “BUSY...PLEASE WAIT” message displays and the memory card is starting format. A “COMPLETED” message displays when finish formatting. All data will be deleted including protected files. Be sure to download important files to your computer before formatting.
Battery Type	<p>To ensure the camera displays battery level correctly, set the type to match the batteries used.</p> <p>Alkaline / NiMH / Lithium / Qxyride</p>
Reset All	<p>Resets the entire menu and button operation settings to initial default.</p> <p>The following settings do not change after Reset All:</p> <ul style="list-style-type: none"> Date & Time setting Language setting TV out setting Battery Type

Basic Recording

Recording Still Images

1 Turn the power on, and set the camera to the REC mode (page 13).

2 Compose the subject on the monitor.

- Aim the focus area (1) to the subject that you want to take.

3 Half press the shutter button to focus the image.

- The focus area (1) becomes green while in focus, then shutter speed (2), aperture value (3) and ISO value (4) are displayed.
- If the shutter speed is slow or the possibility that image may be blurred, the shake warning icon !👉 may appear on the LCD monitor. To avoid this, use a tripod to stabilize the camera when recording images.

4 Take a picture.

- Press the shutter button fully to take a picture.

! Caution

- Make sure that your fingers or the wrist strap does not block the lens.

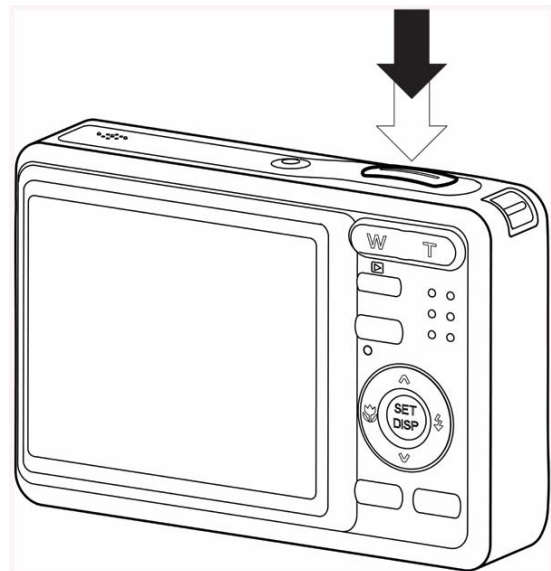
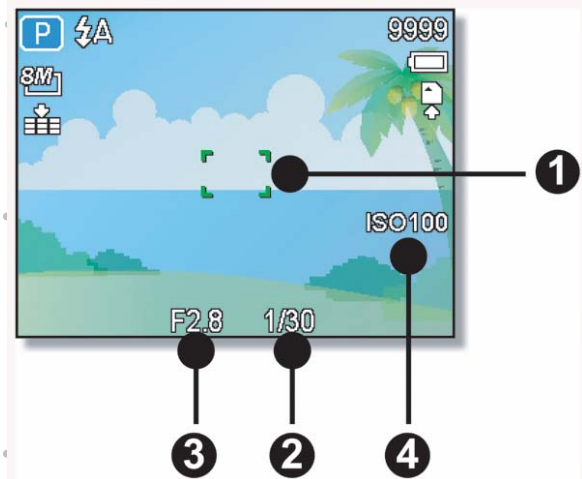

Using the Q mode

The Q mode provides a simplified camera interface. Larger icons and fewer controls make it easier to take pictures anytime, especially for the beginners and elder users.

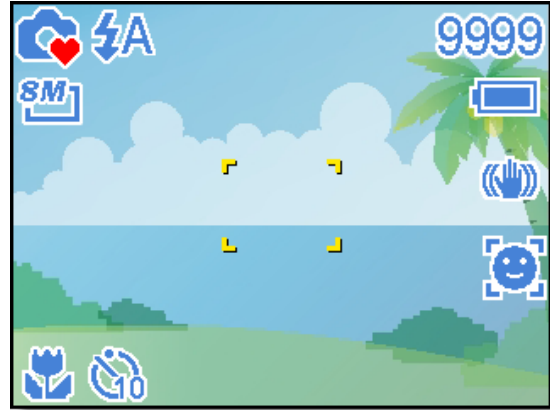

You can use only the basic settings in the Q mode:

Button	Flash: Auto / Red eye / Force on / Slow sync / Force off
	Macro: Off / On
	SET/DISP: OSD on / Guide line / OSD off
Menu	Resolution: 8M / 3:2 / 16:9 / 6M / 4M / 2M / VGA
	Drive Mode: Off / 2 sec. / 10 sec. / Double / Burst
	Stabilizer: Off / On
	Face Tracking: Off / On
	Photo Frame: 10 frames can be selected
	Beep: Off / On
	Auto Review: Off / 1 sec. / 3 sec. / 5 sec.

Rest of settings will not be controlled as below:

Fixed setting (*)	<ul style="list-style-type: none"> • Quality: S.Fine • Metering: Multi • White balance: Auto • ISO: Auto • Exposure: Auto • AEB: Off 	<ul style="list-style-type: none"> • Highlight: Off • Sharpness: Normal • Effect: Off • Date Stamp: Date & Time • Digital Zoom: Off
Utility setting (**)	<ul style="list-style-type: none"> • Shutter sound • Start-up sound • Power save • Date & Time • Language 	<ul style="list-style-type: none"> • File No. • TV out • USB • Start-up image







(*)Fixed setting: Settings are fixed in Q mode.

(**)Utility setting: Use the same setting as last mode used.



Setting Image Size and Quality

You can select lower image resolution and quality to decrease the image size to capture more images. Choose a suitable setting according to the desired image quality and purpose. For details, see page 15.

Resolution Values

Image Size		Print Size	
	3264 x 2448	Printing larger than A4-size.	Larger ↑ ↓ Smaller
	3264 x 2176		
	3264 x 1840		
	2816 x 2112		
	2272 x 1704		
	1600 x 1200	Printing to postcards or attaching to e-mail.	
	640x480		

Quality Values

Compression		Purpose	
	Super Fine	Shoot higher quality images.	Higher Quality ↑ ↓ Lower Quality
	Fine	Shoot normal quality images.	
	Normal	Shoot for more images.	

Using the Zoom Function

Your camera has a combination of optical and digital zoom functions that allows you to zoom in on far away subjects or zoom out for a wide angle shot.

The optical zoom is achieved by mechanically adjusting the lens of the camera. The digital zoom enlarges or shrinks the image using a software process.

1 Select the zoom setting, and point the camera at the subject.

2 Press the zoom button (1) to compose the image.

[W]: zoom out for a wide-angle shot.

[T]: zoom in for a telephoto shot.

- When the zoom button is pressed, the zoom bar appears on the LCD monitor.
- When the optical zoom (2) factor is at maximum, zooming stops temporarily. Press the [T] again, the camera switches to the digital zoom (3) automatically and zooming continues.
- The digital zoom (3) will not activate in movie recording.

3 Press shutter button to take a picture.

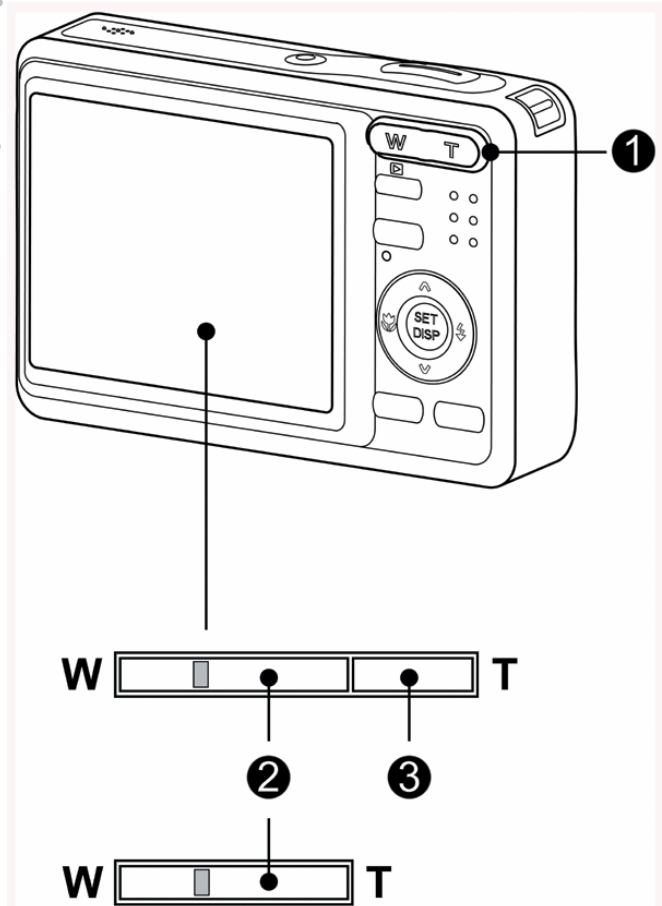

Tips

- Digital zoom works by enlarging the center portion of an image through a software interpolation process.
- The digital zoom is used to achieve magnification levels up to approx. 4 times.

Using the Flash

The flash is not only for taking pictures when there is insufficient light, but also when the subject is in shade or in backlight conditions. Press the flash button to cycle your camera through the various flash modes. The flash will not activate when continuous shooting or movie recording.

1 Turn the power on, and set the camera to the REC mode (☞ page 13).

2 Press the flash button (⚡) to change the flash mode.

- Each time the flash button is pressed, the flash icon (⚡) changes.

⚡A Auto flash:

Flash fires automatically when shooting conditions require extra lighting.

⚡👁 Red-eye reduction:

Flash strobos to let the subject's eyes adjust to the flash, then fires again to take the actual image. Your camera will detect the subject brightness and use the flash only when required.

⚡ Force on:

Flash fires every time you take a photo, regardless of lighting conditions.

S⚡ Slow sync:

Flash fires with a slow shutter speed.

⚡ Force off:

The flash never fires even in dark situation.

3 Press shutter button to take a picture.

! Caution

- The flash charging time may increase when the battery is low.
- The available flash settings are limited depending on the REC mode you selected (☞ page 53).

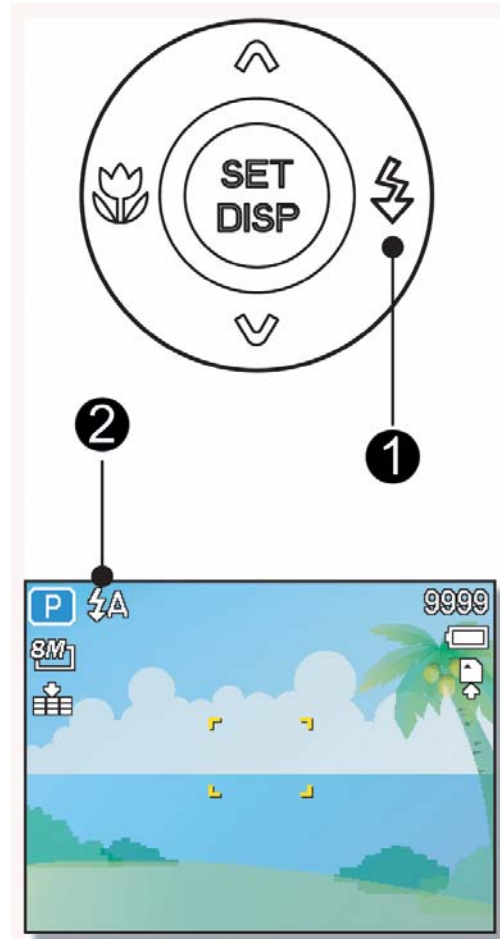

Using the Macro

Your camera is equipped with a macro function that allows you to focus on very close subjects. In macro mode you can focus on subjects 15 cm from the lens when in the maximum wide angle setting and 40 cm in the maximum telephoto setting.

1 Turn the power on, and set the camera to the REC mode (☞ page 13).

2 Press the macro button (❶) enters the macro mode.

- The macro icon (❷) displays in the LCD monitor.
- To leave the macro mode, press the macro button (❶) again.

3 Press shutter button to take a picture.

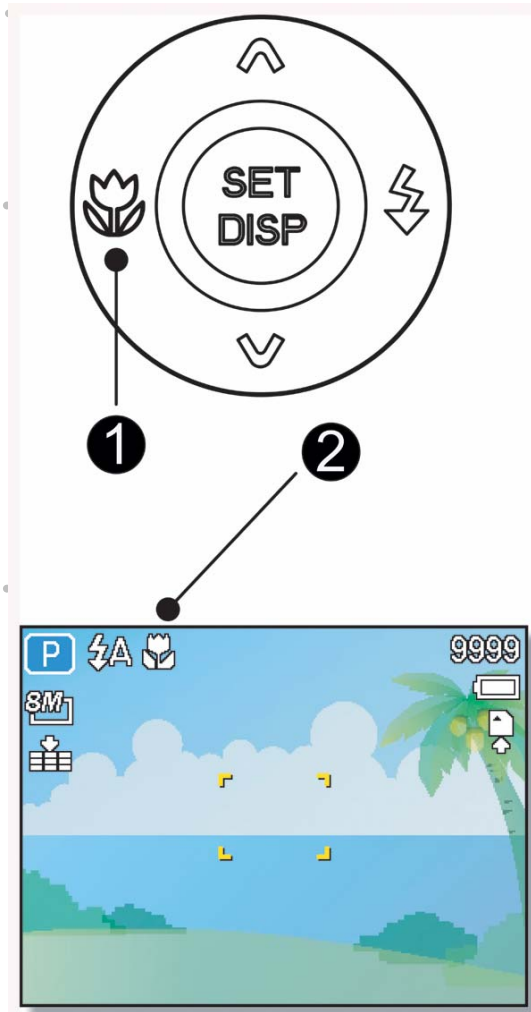

Tips

- Distances referred to measure the distance between the camera lens surface and the subject.

Using the Self-timer & Burst

Use the self-timer to set a delay from the time the shutter button is pressed to the time the image is shot. Use the burst to record continuous still images shooting.

1 Turn the power on, and set the camera to the REC mode (page 13).

2 Open the REC menu (page 15).

- Use ◀ or ▶ to select [Drive mode] from the REC menu.

3 Change the setting.

- Press ▲ or ▼ to select a drive mode, then press the **SET** button.

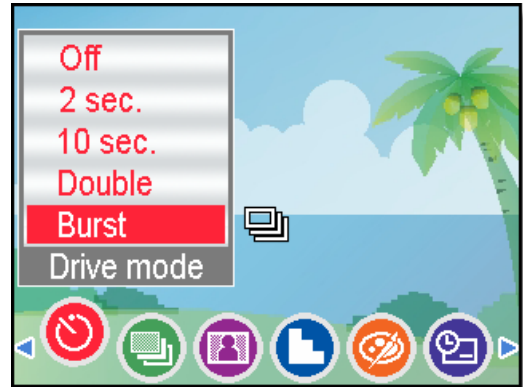

Off:
Record a single image.

 **2 sec.:**
The shutter release will be delay for 2 seconds.

 **10 sec.:**
The shutter release will be delay for 10 seconds.

 **Double:**
Record two images in a shot after pressing the shutter release button 10 and 12 seconds.

 **Burst:**
Keep pressing the shutter button fully to take continuous shooting.
Release the shutter button to stop shooting.

4 Press shutter button to take a picture.

? Tips

- When using the self-timer function, be sure to use a tripod or place the digital camera on a level, stable surface.

Using the Aperture Priority

In this mode, you can set an aperture value to match the brightness. A higher aperture value brings the background out of focus. Selecting a lower aperture value allows you to soft the background.

1 Turn the power on, and set the camera to the Aperture Priority (☞ page 14).

2 Adjust the aperture value by pressing ▲ or ▼ button.

3 Press shutter button to take a picture.



? Tips

- The larger the aperture value the smaller the lens opening, allowing less light to enter the camera.

Using the Shutter Priority

In this mode, you can set a shutter speed to match the brightness. Faster shutter speeds allow you to take a sharp picture of a moving subject while slower speeds create a trail effect and allow you to shoot without a flash in dark areas.

1 Turn the power on, and set the camera to the Shutter Priority (☞ page 14).

2 Adjust the shutter speed by pressing ▲ or ▼ button.

3 Press shutter button to take a picture.



Using the Manual Exposure

You can manually set the shutter speed and aperture to achieve a particular effect.

1
Turn the power on, and set the camera to the Manual Exposure (☞ page 14).

2
Use the SET button to switch between aperture value and shutter speed control. Press ▲ or ▼ to adjust the setting.

3
Press shutter button to take a picture.

- Press the shutter button halfway, the difference between the standard exposure and the selected exposure appears in red.



Recording Movie Clips

1 Turn the power on, and set the camera to the Movie mode (☞ page 13).

2 Compose the subject on the monitor.

- Aim the focus area (④) to the subject that you want to take.
- The LCD monitor displays the available recording time (③).

3 Start recording.

- Press the shutter button (①) to start recording.
- Using the zoom button (②) to adjust the image size.
- The White Balance is set and locked to the settings of the first frame

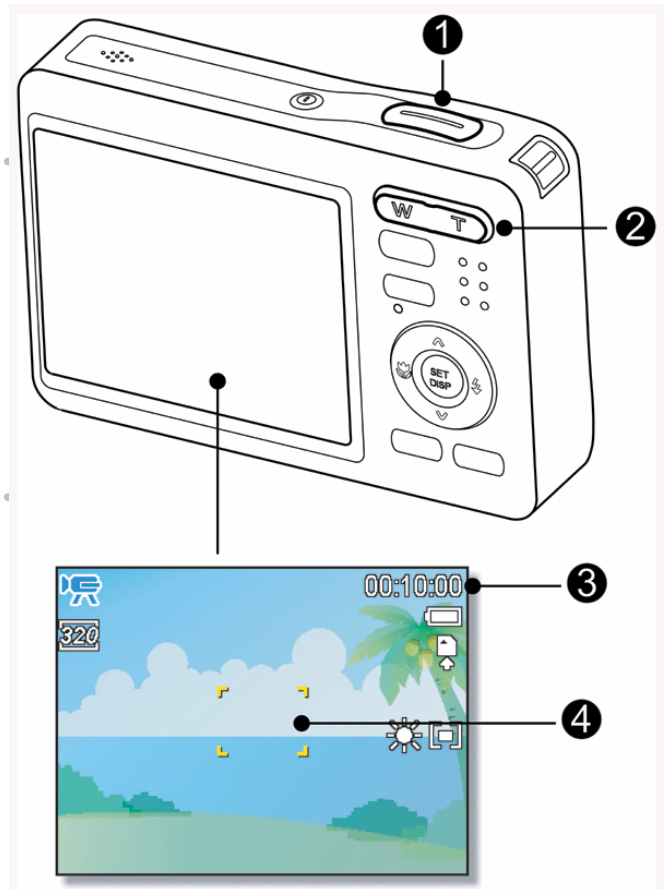

! Caution

- Sound cannot be recorded while pressing the zoom button..
- The digital zoom cannot be used in Movie mode.

4 Finish recording.

- Press the shutter again to end recording.
- The camera will stop recording automatically when the memory capacity has been reached.

Setting the Movie Size

Movie Size and Frame Rate

Resolution		Frame Rate	
<u>16:9</u>	720 x 400	30 frames/sec.	Higher Quality ↕ Lower Quality
<u>640</u>	640 x 480		
<u>320</u>	320 x 240		

Recording Audio Clips

1

Turn the power on, and set the camera to the **Voice REC** mode (👉 page 13).

2

Press the shutter button to start recording.

- The voices are recorded from the microphone of the camera. Be careful to avoid touching the microphone while recording.

3

Press the shutter button again to end recording.

- The camera will stop recording automatically when the memory capacity has been reached.

Playing Back Audio Clips

1

Turn the power on, and set the camera to the **PLAYBACK** mode (👉 page 13).

2

Press ◀ or ▶ to select the audio clip that you want to playback.

3

Start playing back.

- Press ▲ to start playing the audio clip.
- Press ▼ to stop the audio clip, or press ▲ to pause it. When audio clip paused, press ▲ again to resume.



Recording a Voice Memo

You can add a voice memo to the still images after you record it.

1 Turn the power on, and set the camera to the **PLAYBACK** mode (☞ page 13).

2 Press ◀ or ▶ to select a still image that you want to add a voice memo.

- If the image already has the voice memo recorded, the  appears on the LCD monitor. The new recording will replace the previous one.

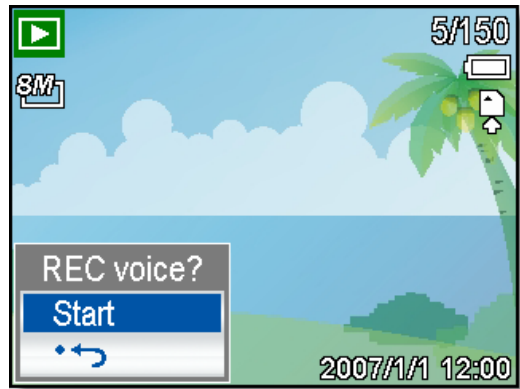

3 Open the **PLAYBACK** menu.

- Press the **MENU** button, using four-way control to select **Voice Memo** () and press the **SET** button.

4 Press the **SET** button to start recording for 30 seconds.

- Press the **SET** button again to end recording.

! Caution

- The voice memo cannot be added to a movie clip or a protected image.
- You cannot delete only the voice memo. When you delete the image, the attached voice memo is also deleted.

Playing Back a Voice Memo

1 Turn the power on, and set the camera to the **PLAY** mode (☞ page 13).

2 Press ◀ or ▶ to select the image that has the voice memo recorded.



3 Start playing back.

- Press ▲ to start playing the voice memo.
- Press ▼ to stop the voice memo, or press ▲ to pause it. When voice memo paused, press ▲ again to resume.

Other Recording Functions





Setting the Metering

There are 3 different light metering options available on your camera.

Option	Description
	Light is measured from the entire shooting screen, but gives more importance to the values near the center.
	Selects an exposure based on readings from multiple points in the subject area.
	Selects an exposure based on a single reading taken from the center of your picture.

Setting the White Balance

Adjust the white balance to match different light sources such as sunlight, incandescent (tungsten) lighting or, fluorescent lighting.

Option	Description
AUTO	Automatically corrects white balance. Ideal for general photography.
	Adjusts for bright sun conditions, or natural light conditions.
	Adjusts for cloudy days or twilight conditions.
	Adjusts for normal indoor lighting conditions. Corrects the orange hue of household light bulbs. Ideal for indoor photos under tungsten or halogen lighting without a flash.
	Adjusts for fluorescent lighting. Corrects the green hue of fluorescent lighting. Ideal for indoor photos under fluorescent lighting without a flash.
	For more accurate adjustment or when the light source cannot be specified.



Tips

- Point the camera at a white piece of paper or similar object under the lighting conditions for which you want to set the white balance, and then press the Shutter button.

Setting the ISO

With the initial settings, the ISO sensitivity is automatically set according to the brightness of the subject.

Option	Description
Auto	Sets the ISO sensitivity automatically.
ISO 50	Sets the sensitivity to ISO 50 equivalent.
ISO 100	Sets the sensitivity to ISO 100 equivalent.
ISO 200	Sets the sensitivity to ISO 200 equivalent.
ISO 400	Sets the sensitivity to ISO 400 equivalent.
ISO 800	Sets the sensitivity to ISO 800 equivalent.
ISO 1600	Sets the sensitivity to ISO 1600 equivalent.



Tips

- Higher ISO speeds increase the image noise. To take clean images, use as low an ISO speed as possible.



Setting the Exposure

Set the exposure value manually to compensate for unusual lighting conditions such as indirect indoor lighting, dark backgrounds, and strong backlighting.

Setting the AEB

Sets the auto exposure bracketing (AEB) to shoot 3 continuous images, each with a different exposure setting: correctly exposed, underexposed, and overexposed.

Setting the Highlight

Make the subject stand out from its surroundings. The subject will be in focus in three different ranges:  /  / 





Tips

- The Photo Frame and Face Tracking cannot be used as using the Highlight.

Setting the Sharpness

You can select whether you want the image to have sharp or soft outlines.

Option	Description
	The edges of the image are emphasized. The edges will become sharp, but noise may occur in the recording image.
	The edges of the image are sharp. This is suitable for printing.
	The edges of the image are softened. This is suitable for editing images on PC.

Setting the Photo Edit

You can add special effects to your images in Record mode or in Playback mode.

Option	Description
Off	No effect is added to the image.
	Red eye removal. (Playback only)
B&W	Convert image to black & white.
Sepia	Recorded image will be stored in a sepia tone.
Negative	Opposite what they were in the original image.
Mosaic	Add mosaic tiles to the images. (Playback only)
Red	The image becomes reddish.
Green	The image becomes greenish.
Blue	The image becomes bluish.

Setting Date Stamp

The Date Stamp function can be used to add a date to your pictures as you take them.

Option	Description
Off	Do not add the recorded date & time to printed images.
Date	Only add the recorded date to printed images.
Date & Time	Add the recorded date & time to printed images.

Setting Stabilizer

With more sensibility and faster shutter speed to bright up the pictures, effectively prevent blur image caused by hand shack or target movement, one can take good pictures with little effort.

Setting Face tracking

After initializing face tracking function, the lens will lock the main character in the picture and follow the movements. Also use auto digital zoom technology to retract and extract zoom lens that allows you to become the focus of lens.



Tips

- Pressing the shutter halfway showing green AF area means focus is complete.
- Face tracking is powered by Arcsoft.
- Under some environmental influences, face tracking function may be limited.
- The Highlight and Photo Frame cannot be used as using the Face Tracking.

Setting Photo Frame

You can add 10 kinds of frames to still images, making them more interesting.



Tips

- This feature only available with still images (except 3:2 and 16:9).
- The Highlight and Face Tracking cannot be used as using the Photo Frame.

Playback

Playing Back Images

1 Turn the power on, and set the camera to the **PLAYBACK** mode (☞ page 13).

- The latest recorded image appears on the LCD monitor.
- If there are no images stored, a message **[No image]** appears.

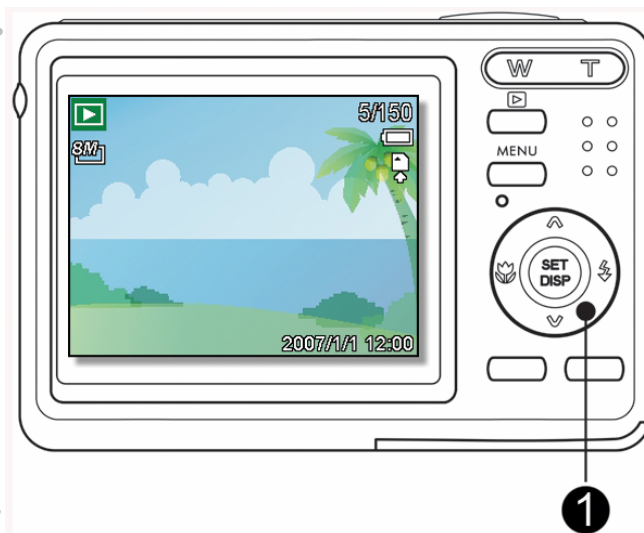

2 Press the four-way control ◀ or ▶ (1).

- ◀: displays the previous image.
- ▶: displays the next image.

? Tips

- Holding down ◀ or ▶ scrolls images in a high speed.

Playing Back Movie Clips

1 Turn the power on, and set the camera to the **PLAYBACK** mode (☞ page 13).

2 Press ◀ or ▶ to select a movie clip that you want to playback.

3 Start playing back.

- Press ▲ to start playing the movie clip.
- Press ▼ to stop the movie clip, or press ▲ to pause it. When the movie paused, press ▲ again to resume.

? Tips

- During movie playing back, press ▶ to fast forward or press ◀ to rewind it.
- Press the shutter to capture the still image from the movie clip while it had paused.

1

Turn the power on, and set the camera to the **PLAYBACK** mode (👉 page 13).

2

Select an image.

- Press ◀ or ▶ (⏮) to select the image that you want to magnify or trimming.
- Only still images can be magnified and trimmed.

3

Magnify the image.

- Press [T] (1) to magnify the image, and the central portion of the image is displayed. You can use the arrow button (⏮) to view different parts of the magnified image.
- Press the **MENU** button (2) to return to the normal size.

4

Trim the image.

- Press the **SET** button (3) to set the image trimming.

5

Save the image.

- Press the **SET** button (3) again to trim the selected image and save it as a new one.

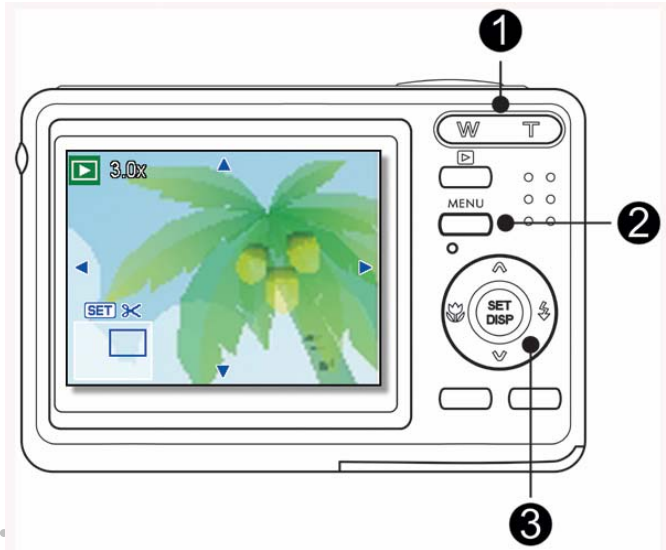

Viewing in Thumbnail

1 Turn the power on, and set the camera to the **PLAYBACK** mode (page 13).

2 Press the zoom button [W], a thumbnail screen is displayed.

3 Use the four-way control to select the desired image, and press [T] or the **SET** button to show the selected image in full screen.



? Tips

- You can protect or delete multiple images in thumbnail, see page 40, 42.

Playing a Slide Show

1 Turn the power on, and set the camera to the **PLAYBACK** mode (page 13).

2 Enter the slide show.

- Press the **MENU** button (1), use the four-way control (2) to select **Slide Show** (📺) and press the **SET** button (2).

3 Change the slide show settings.

- Use the four-way control (2) to set the slideshow interval (🕒), effect (📷) and repeat (🔄).
- You can set the interval between 1~10 seconds.

4 Playing the slide show.

- Press the **SET** button (2) to start the slideshow.
- During the slideshow, press the **SET** button (2) to pause the slideshow and press the **SET** button again to resume.

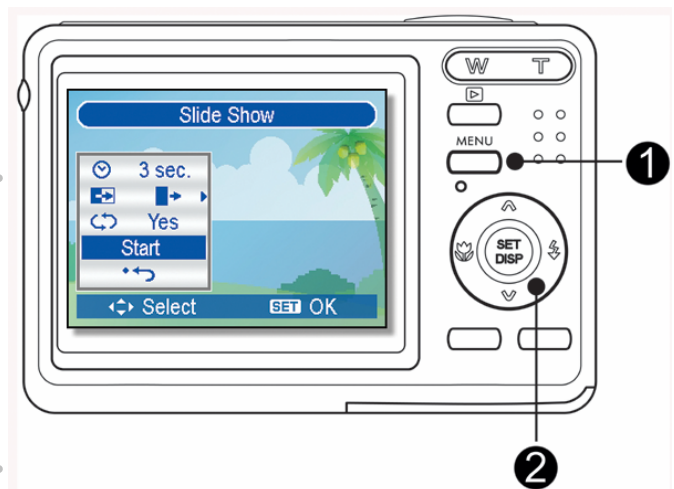

Deleting Files

Deleting a Single File

1 Turn the power on, and set the camera to the **PLAYBACK** mode (👉 page 13).

2 Open the menu.

- Press the **MENU** button (❶), then use the four-way control (❷) to select **Delete** (🗑️) and press the **SET** button (❸).

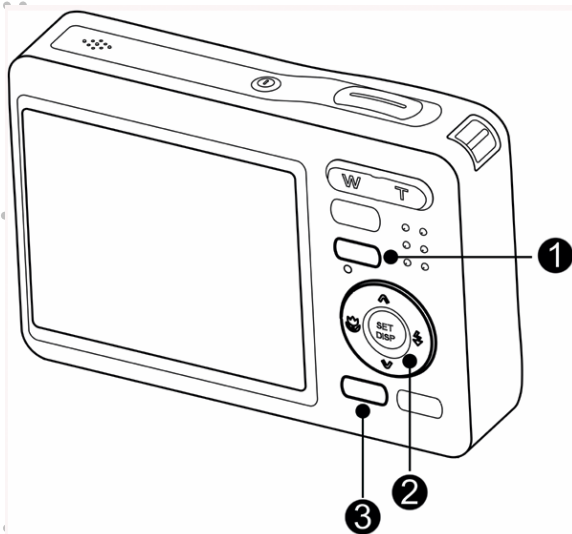

3 Press ▲ or ▼ (❷) to select **[SINGLE]**, and then press the **SET** button (❸).

4 Press ◀ or ▶ (❷) to select the image you want to delete.

5 Press the **SET** button (❸) to delete the image.

- Repeat step 4~5 to delete images.



Tips

- To quickly delete the current display image
 1. Select the image you want to delete.
 2. Press the **Delete** button (❸) to show a confirmation.
 3. Press the **SET** button (❷) to delete the current display image.
- Protected images cannot be deleted with this function.

Deleting Multiple Files

1 Turn the power on, and set the camera to the thumbnail screen (☞ page 38).

2 Open the menu.

- Press the **MENU** button, then Press ◀ or ▶ to select to select **Delete** (🗑️) and press the **SET** button.



3 Press ▲ or ▼ to select [Select], and then press the **SET** button.

- The frame of the selected image turns green.

4 Select multiple images.

- Use the four-way control to select the image.
- Press the **SET** button toggles the 🗑️ on and off. Repeat this step until all images that you want to delete are displayed with an icon 🗑️.

5 Delete images.

- Press the **MENU** button, then select [Yes] and press the **SET** button. All selected images will be deleted.
- To cancel delete, press the **MENU** button in this step.

Deleting All Files

1 Turn the power on, and set the camera to the **PLAYBACK** mode (☞ page 13).

2 Open the menu.

- Press the **MENU** button, then use the four-way control to select **Delete** (🗑️) and press the **SET** button.
- You can open the menu in full screen or in thumbnail.

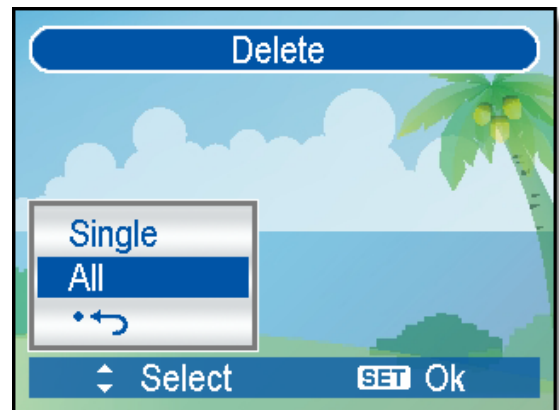

3 Press ▲ or ▼ to select [ALL], and then press the **SET** button.

4 Press the **SET** button to delete all unprotected images.

Protecting a Single File

1

Turn the power on, and set the camera to the **PLAYBACK** mode (☞ page 13).

2

Open the menu.

- Press the **MENU** button, then use the four-way control to select **Protect** (⊙π) and press the **SET** button.

3

Press ▲ or ▼ to select [**SINGLE**], and then press the **SET** button.

4

Press ◀ or ▶ to select the image you want to protect.

5

Press the **SET** button to protect the image.

- When the file is locked, the ⊙π displays on the LCD monitor.
- Repeat step 4~5 to protect images.
- To unlock the file, press the **SET** button again in step 5. The ⊙π will disappear and the file is unlocked.

Protecting All Files

1

Turn the power on, and set the camera to the **PLAYBACK** mode (☞ page 13).

2

Open the menu.

- Press the **MENU** button, then use the four-way control to select **Protect** (⊙π) and press the **SET** button.
- You can open the menu in full screen or in thumbnail.

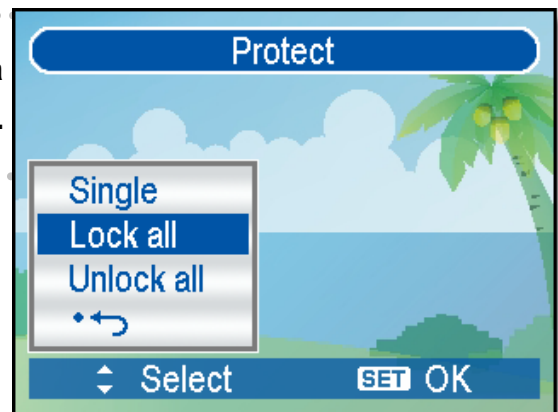

3

Press ▲ or ▼ to select [**Lock all**], and then press the **SET** button.

- To unlock all files, select [**Unlock all**] in this step, then press the **SET** button.

4

Press the **SET** button to protect all images.

Protecting Multiple Files

1

Turn the power on, and set the camera to the thumbnail screen (page 38).

2

Open the menu.

- Press the **MENU** button, then Press ◀ or ▶ to select to select **Protect** (ⓘ) and press the **SET** button.



3

Press ▲ or ▼ to select [Select], and then press the **SET** button.

- The frame of the selected image turns green.

4

Select multiple images.

- Use the four-way control to select the image.
- Press the **SET** button toggles the ⓘ on and off. Repeat this step until all images that you want to protect are displayed with an ⓘ.

5

Protect images.

- Press the **MENU** button, then select [**Yes**] and press the **SET** button. All selected images will be protected.
- To cancel protect, press the **MENU** button in this step.

Editing Images

Rotating Still Images

1

Turn the power on, and set the camera to the **PLAYBACK** mode (👉 page 13).

2

Press ◀ or ▶ to select the image you want to rotate.

3

Open the menu.

- Press the **MENU** button, then use the four-way control to select **Rotate** (🔄) and press the **SET** button.

4

Press the **SET** button to rotate the image.

- Each press rotates the image 90 degrees in clockwise.

5

Press ▲ or ▼ to select **OK**, and then press the **SET** button to finish rotating.

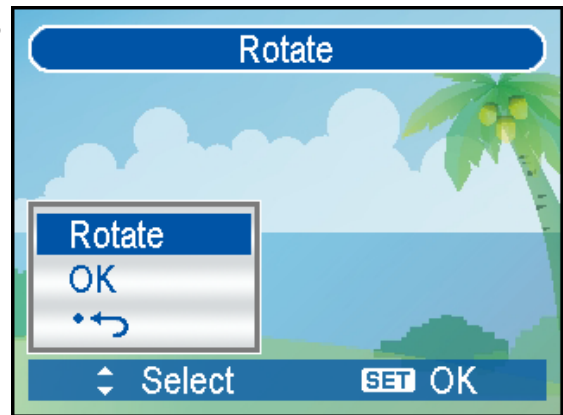

Changing the Image Size

1

Turn the power on, and set the camera to the **PLAYBACK** mode (👉 page 13).

2

Press ◀ or ▶ to select the image you want to resize.

3

Open the menu.

- Press the **MENU** button, then use the four-way control to select **Resize** (📐) and press the **SET** button.

4

Press ▲ or ▼ to select an option, and then press the **SET** button.

- The resized image will be saved as a new file.

! Caution

- Only a large size image can be resize to a smaller one.

Changing the Image with Effects

You may use Red Eye Removal to remove the red eye caused by flash from original photo. Or use color filters to save as a new image.

1

Turn the power on, and set the camera to the **PLAYBACK** mode (👉 page 13).

2

Press ◀ or ▶ to select the image you want to add the effect.

3

Open the menu.

- Press the **MENU** button, then use the four-way control to select **Effect** (👁️) and press the **SET** button.

4

Press ▲ or ▼ to select an option, and then press the **SET** button.

- The edited image will be saved as a new file.

Choosing the Image with Photo Frame

1

Turn the power on, and set the camera to the **PLAYBACK** mode (👉 page 13).

2

Press ◀ or ▶ to select the image you want to add the photo frame.

3

Open the menu.

- Press the **MENU** button, then use the four-way control to select **Photo Frames** (🖼️) and press the **SET** button.

4

Press ▲ or ▼ to select the image you want, then press the **SET** button to apply the choice.

- The edited image will be saved as a new file.

Copying the Files

You may copy the data from the camera's internal memory to the memory card for convenience.

- 1
Be sure you have inserted a memory card into your digital camera. Set the camera to the PLAYBACK mode.
(☞ page 13).

- 2
Open the menu.
 - Press the **MENU** button, then use the four-way control to select **Copy to card** (🔧) and press the **SET** button.

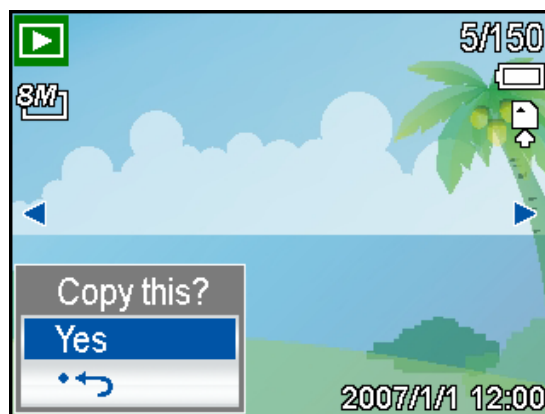

- 3
Press ▲ or ▼ to select [Single], then press the SET button.
 - To copy all images to a memory card, select **[All]**.

- 4
Press ◀ or ▶ to select the image you want to copy to a card.

- 5
Select [Yes] and then press the SET button to start copy.
 - Repeat step 4~5 to copy other images.
 - Press the **MENU** button to complete the setting.

Setting the DPOF

The Digital Print Order Format (DPOF) setting allows you to select images on the memory card for printing and specify the number of print copies in advance using the camera. This is extremely convenient for sending the images to a photo developing service or for printing on a direct print function compatible printer.

1
Turn the power on, and set the camera to the PLAYBACK mode (☞ page 13).

2
Open the menu.

- Press the **MENU** button, then use the four-way control to select **DPOF** (☞) and press the **SET** button.

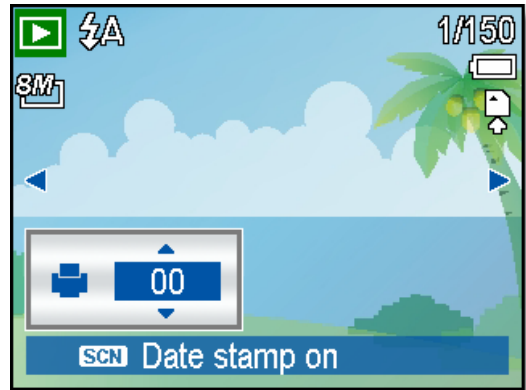

3
Press ▲ or ▼ to select [Single], then press the SET button.

- To set the DPOF setting for all images, select **[All]** in this step.
- To reset all DPOF settings to initial default, select **[Reset]** in this step.

4
Press ◀ or ▶ to select the image you want to print out.

5
Set the number of copies.

- Press ▲ or ▼ to specify the number of copies.
- The number of copies can be set from 0 to 30.
- To cancel this image DPOF setting, set the number of copies to 0.

6
Print the date stamp out.

- Press SCN button to set the date stamp of current image. Press SCN button again to turn off date stamp.
- Repeat step 4~6 to other images for printing.

7
After you finished all image settings, press the SET or MENU button to apply it.

Choosing a Startup Image

- 1
Turn the power on, and set the camera to the **PLAYBACK** mode (👉 page 13).
- 2
Open the menu.
 - Press the **MENU** button, then use the four-way control to select **Start-up Image** (📷) and press the **SET** button.
- 3
Press ◀ or ▶ to select the image you want, then press the **SET** button to apply the choice.
 - A message “Completed” appears.
- 4
Set the camera to the **Setup Menu** (👉 page 17).
- 5
Press ▲ or ▼ to select **Start-up Image** (📷) then press ▶ or the **SET** button.
- 6
Press ▲ or ▼ to select a desired option and press the **SET** button to apply the setting.
 - [Off]: Disable the start-up image.
 - [System]: Use camera default image.
 - [My image]: Use the image that you just specified in step 3.
- 7
Press the **MENU** button to close the menu.

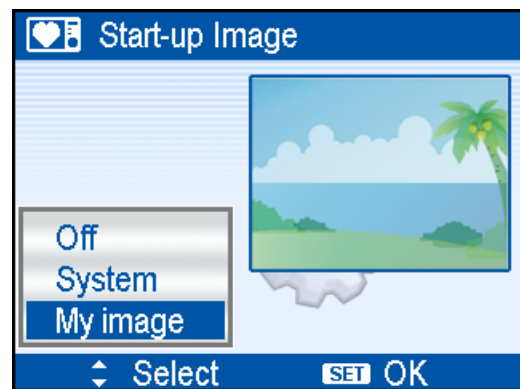

! Caution

- The start-up image will not be deleted even if the original image is deleted or memory formatted.

Making Connections

Connecting the Camera to a TV

You can display recorded images on a television with a supplied AV cable.

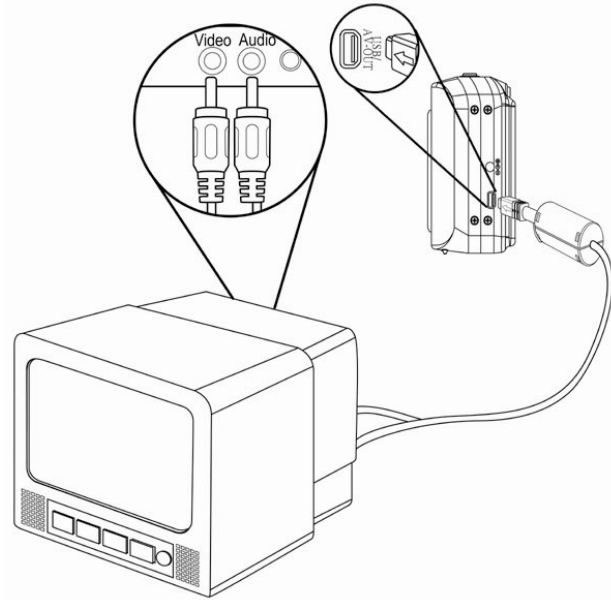

- 1
Set the TV out to match the TV system that you are using (👉 page 19).
- 2
Turn off the camera and the TV.
- 3
Use the supplied AV cable to connect the camera to the TV set.
- 4
Set the TV input signal to Video In.
 - Refer to the documentation included with your TV for more information.
- 5
Display on TV.
 - Everything that would normally appear on the camera's LCD screen, such as photo and video clip playback, slide shows, and image or video capture, appears on the TV.

Connecting the Camera to a PC

There are two ways to download files from the camera's internal memory or memory card to a computer:

- Inserting the memory card into a card reader
- Connecting the camera to a computer using the supplied USB cable

Using the Card Reader

1 Eject the memory card from the camera and insert it in a card reader that is connected to a computer.

2 Open [My Computer] or [Windows Explorer] and double-click the removable drive icon that represents the memory card.

3 Copy images from the card into a directory of your choice on the computer's hard disk.

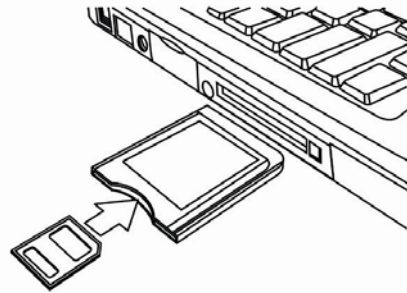

Connecting the Camera to a Computer with the USB Cable

1 Install the USB software driver included with the bundled CD-ROM.

2 Connect the supplied USB cable to the computer's USB port and turn on the camera.

- The LCD screen turns off when the connection to the computer has been successfully completed.

3 Open [My Computer] or [Windows Explorer]. A "Removable Disk" appears in the drive list.

4 Double-click the "Removable Disk" icon to view its contents.

- Files stored on camera are located in the folder name "DCIM".

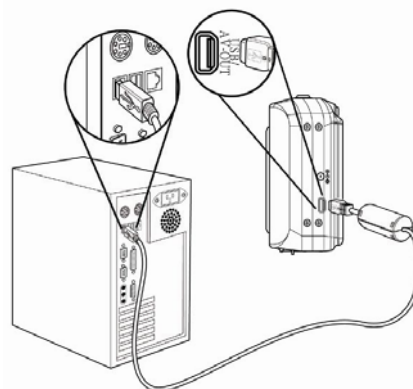

Appendix

About the Folder & File Name

Your digital camera automatically creates a directory of folders in the internal memory or memory card that it uses to organize still images, movie clips and other information.

Folder Structure

Folder name begins with a 3-digit number from 100 to 999 and followed by “DICAM”, each folder holds up to 9999 files. If new files are made, a new folder named in sequence will be made automatically.

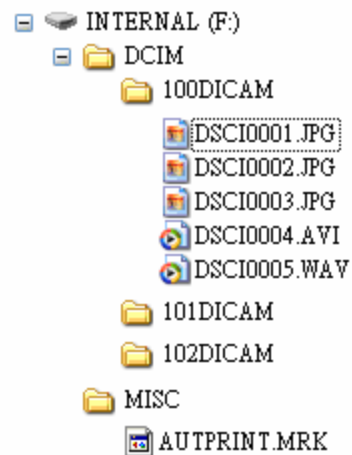

File Naming

File name begins with “DSCI” and are followed by a 4-digit number that increases in sequence. File numbering starts from 0001 when a new folder is created.

If the highest folder number is 999 and highest file number exceeds 9999, the camera will display the warning message “Folder cannot be created”. When it appears, try one of the following ways:

- Reset the file number and plug in a new memory card.
- The folder number and file number are initialized and renumbered from 100 and 0001 respectively.

Caution

- Do not change the folder and file names in the memory card using your computer. It may be unable to playback the data using the digital camera.

Troubleshooting

Problem	Cause	Solution
Power does not turn on.	Battery is inserted in the wrong direction.	Reload battery in the correct direction.
	Batteries are dead.	Replace or recharge batteries.
	The battery compartment door is open.	Make sure the battery compartment door is securely closed.
The camera does not take pictures.	The flash is charging.	Wait for the flash to charge.
	Memory is full.	Insert a new memory card.
	Memory card is not formatted correctly.	The card may be defective, use a new card.
Image is not recorded when the shutter button is pressed.	The Flash is charge.	Wait for the flash to charge.
	Memory is full.	Insert a new memory card.
The flash does not fire.	Flash is set to OFF.	Set the flash to any mode except off.
Image is blurry or out of focus.	The camera was moving when the image was captured.	Hold the camera steady when shooting picture.
	The subject was beyond the range within which the camera can focus.	Turn the Macro mode on if the subject is within 15 cm or 40 cm. Do not use Macro mode when shooting distant subjects.
Image is not displayed on the LCD monitor.	A memory card with non-DCIF images (recorded with other camera) is loaded.	This camera cannot display non-DCIF images.
Recorded images are not saved in memory.	The camera was turned off / powered down before the image was stored in memory.	If the battery low indicator appears on the LCD monitor, replace the battery immediately.
Cannot transfer images to a computer after connecting the USB cable.	USB driver is not installed.	Install the USB driver before you connect the camera to a computer / turn the camera on.
Card error	The memory card format may not be correct.	Re-format the memory card to the FAT format using a card reader in Windows.

Specifications

Sensor	8 megapixels CCD, Size : 1/2.5 inch
Lens	Focal Length : f = 6.2 (W) ~ 18.6 (T) mm , 3X optical zoom, 4X digital zoom
LCD	2.5" LCD display
Focus range	Normal: 80 cm ~ Infinity , Macro: (W) 15 cm ~ 1 m / (T) 40 cm~ 1 m
Aperture	F/ 2.8 (W), 5.2 (T)
Shutter	8 ~ 1/2000 sec.
File format	Still Image: EXIF 2.2 compatible format (JPEG compression), DCF compatible. Support DPOF, (PictBridge available) Video: AVI , Audio: WAV
Resolution	Still Image: 3264 x 2448 (8M) / 3264 x 2176 (3:2) / 3264 x 1840 (16:9) / 2816 x 2112 (6M) / 2272 x 1704 (4M) / 1600 x 1200 (2M) / 640 x 480 (VGA) , Video: 720 x 400 / 640 x 480 / 320 x 240
Scene mode	Program /Movie / Voice REC / Sunset / Backlight / Q. Mode / Landscape / Portrait / Snow / Fireworks / Night scene / Kids / Food / Building / Text / Smile Capture
Sensitivity	Auto / ISO 50 / ISO 100 / ISO 200 / ISO 400 / ISO 800 / ISO 1600
White balance	Auto / Daylight / Cloudy / Tungsten / Fluorescent (H) / Fluorescent (L) / Custom
Exposure control	-2EV to +2EV in 1/3 step
Metering	Center-weighted / Multi / Spot
Burst	Depends on the capacity of the memory. (no limit)
Self-timer	2 sec. / 10 sec. / Double
Flash	Auto / Red eye reduction / Always on / Slow sync / Always off
Photo effect	Black & White / Sepia / Negative / Mosaic / Red eye removal / Red / Green / Blue
Storage	16 MB internal memory / SD Card / SDHC 8 GB
TV system	NTSC / PAL
Power supply	AA alkaline battery x2
Ambient temperature	Operating: 0° C to 40° C Storage: -20 to 60° C
Microphone	Built-in
Speaker	Built-in
Dimension	Camera Body (W x H x T): 89.5 x 61.3 x 27 mm
Weight	Camera Body w/o battery: Approx. 125 (g)

*These specifications are subject to change without notice.

Function Available List

Function	Mode	Still Capture																				
		Scene Mode																				
		Shutter & Lens																				
Focus	One time AF	●	●	●	●	●	●	●	●	●	●	●	●	●	●	●	●	●	●	●	●	
	Continuous AF	×	×	×	×	●	×	×	×	×	×	×	×	×	×	×	×	×	×	×	×	
	Infinity Fixed	×	×	●	×	×	×	×	×	×	×	×	×	×	×	×	×	×	×	×	×	
	Shutter speed	$\frac{1}{2000}$	$\frac{8}{12000}$	$\frac{1}{2000}$	$\frac{1}{2000}$	$\frac{1}{2000}$	$\frac{1}{2000}$	$\frac{1}{2000}$	$\frac{1}{2000}$	$\frac{1}{2000}$	$\frac{1}{2000}$	$\frac{1}{2000}$	$\frac{1}{2000}$	$\frac{1}{2000}$	$\frac{1}{2000}$	$\frac{1}{2000}$	$\frac{1}{2000}$	$\frac{1}{2000}$	$\frac{1}{15}$ ~ $\frac{1}{2000}$	$\frac{1}{2000}$	$\frac{1}{2000}$	×
		Button																				
Macro	Off	○	○	○	○	○	○	○	○	○	○	○	○	○	○	○	○	○	○	○	○	○
	On	○	○	○	○	○	○	○	○	○	○	○	○	○	○	○	○	○	○	○	○	○
Flash	Auto	◆	×	×	×	○	○	○	○	○	○	○	○	○	○	○	○	○	○	○	○	○
	Red eye	○	○	○	○	○	○	○	○	○	○	○	○	○	○	○	○	○	○	○	○	○
	Force on	○	○	○	○	○	○	○	○	○	○	○	○	○	○	○	○	○	○	○	○	○
	Slow sync	○	○	○	○	○	○	○	○	○	○	○	○	○	○	○	○	○	○	○	○	○
	Force off	○	○	○	○	○	○	○	○	○	○	○	○	○	○	○	○	○	○	○	○	○
Up & Down	Aperture value	×	○	×	○	○	○	○	○	○	○	○	○	○	○	○	○	○	○	○	○	○
	Shutter speed	×	○	○	○	○	○	○	○	○	○	○	○	○	○	○	○	○	○	○	○	○

Mode	Still Capture											MENU			Still Capture	Still Capture	Still Capture	Still Capture	Still Capture																					
	Scene Mode											Still Capture	Still Capture	Still Capture																										
Function	P	A	S	M	Still Capture	Still Capture	Still Capture	Still Capture	Still Capture	Still Capture	Still Capture				Still Capture	Still Capture	Still Capture	Still Capture	Still Capture	Still Capture	Still Capture																			
8M	◆	O	O	O	O	O	O	O	O	O	O	O	O	O	O	O	O	O	x	x	x	x	x	x	x	x	x	x	x	x	x	x	x	x	x	x	x			
3:2	O	O	O	O	O	O	O	O	O	O	O	O	O	O	O	O	O	O	O	O	O	O	O	O	O	O	O	O	O	O	O	O	O	O	O	O	O	O	O	
16:9	O	O	O	O	O	O	O	O	O	O	O	O	O	O	O	O	O	O	O	O	O	O	O	O	O	O	O	O	O	O	O	O	O	O	O	O	O	O	O	
6M	O	O	O	O	O	O	O	O	O	O	O	O	O	O	O	O	O	O	O	O	O	O	O	O	O	O	O	O	O	O	O	O	O	O	O	O	O	O	O	
4M	O	O	O	O	O	O	O	O	O	O	O	O	O	O	O	O	O	O	O	O	O	O	O	O	O	O	O	O	O	O	O	O	O	O	O	O	O	O	O	
2M	O	O	O	O	O	O	O	O	O	O	O	O	O	O	O	O	O	O	O	O	O	O	O	O	O	O	O	O	O	O	O	O	O	O	O	O	O	O	O	
VGA	O	O	O	O	O	O	O	O	O	O	O	O	O	O	O	O	O	O	O	O	O	O	O	O	O	O	O	O	O	O	O	O	O	O	O	O	O	O	O	
16:9	x	x	x	x	x	x	x	x	x	x	x	x	x	x	x	x	x	x	x	x	x	x	x	x	x	x	x	x	x	x	x	x	x	x	x	x	x	x		
640	x	x	x	x	x	x	x	x	x	x	x	x	x	x	x	x	x	x	x	x	x	x	x	x	x	x	x	x	x	x	x	x	x	x	x	x	x	x	x	
320	x	x	x	x	x	x	x	x	x	x	x	x	x	x	x	x	x	x	x	x	x	x	x	x	x	x	x	x	x	x	x	x	x	x	x	x	x	x	x	
S.Fine	O	O	O	O	O	O	O	O	O	O	O	O	O	O	O	O	O	O	O	O	O	O	O	O	O	O	O	O	O	O	O	O	O	O	O	O	O	O	O	
Fine	◆	O	O	O	O	O	O	O	O	O	O	O	O	O	O	O	O	O	O	O	O	O	O	O	O	O	O	O	O	O	O	O	O	O	O	O	O	O	O	
Normal	O	O	O	O	O	O	O	O	O	O	O	O	O	O	O	O	O	O	O	O	O	O	O	O	O	O	O	O	O	O	O	O	O	O	O	O	O	O	O	
Center	O	O	O	O	O	O	O	O	O	O	O	O	O	O	O	O	O	O	O	O	O	O	O	O	O	O	O	O	O	O	O	O	O	O	O	O	O	O	O	O
Multi	◆	O	O	O	O	O	O	O	O	O	O	O	O	O	O	O	O	O	O	O	O	O	O	O	O	O	O	O	O	O	O	O	O	O	O	O	O	O	O	
Spot	O	O	O	O	O	O	O	O	O	O	O	O	O	O	O	O	O	O	O	O	O	O	O	O	O	O	O	O	O	O	O	O	O	O	O	O	O	O	O	
	Resolution						Movie Size						Quality			Metering																								

Mode	Still Capture												MENU									
	P	A	S	M	Scene Mode	Portrait	Smiley	Smiley	Smiley	Smiley	Smiley	Smiley	Smiley	Smiley	Smiley	Smiley	Smiley	Smiley	Smiley	Smiley		
Hard	○	○	○	○	●	○	○	○	○	○	○	○	○	○	○	○	○	○	○	○	○	
Normal	◇	○	○	○	●	○	○	○	○	○	○	○	○	○	○	○	○	○	○	○	○	○
Soft	○	○	○	○	●	○	○	○	○	○	○	○	○	○	○	○	○	○	○	○	○	○
Off	●	○	○	○	●	○	○	○	○	○	○	○	○	○	○	○	○	○	○	○	○	○
B&W	○	○	○	○	○	○	○	○	○	○	○	○	○	○	○	○	○	○	○	○	○	○
Sepia	○	○	○	○	○	○	○	○	○	○	○	○	○	○	○	○	○	○	○	○	○	○
Negative	○	○	○	○	○	○	○	○	○	○	○	○	○	○	○	○	○	○	○	○	○	○
Red	○	○	○	○	○	○	○	○	○	○	○	○	○	○	○	○	○	○	○	○	○	○
Green	○	○	○	○	○	○	○	○	○	○	○	○	○	○	○	○	○	○	○	○	○	○
Blue	○	○	○	○	○	○	○	○	○	○	○	○	○	○	○	○	○	○	○	○	○	○
Off	◇	○	○	○	○	○	○	○	○	○	○	○	○	○	○	○	○	○	○	○	○	○
Date	○	○	○	○	○	○	○	○	○	○	○	○	○	○	○	○	○	○	○	○	○	○
Date & Time	○	○	○	○	○	○	○	○	○	○	○	○	○	○	○	○	○	○	○	○	○	○
Off	◇	○	○	○	○	○	○	○	○	○	○	○	○	○	○	○	○	○	○	○	○	○
On	○	○	○	○	○	○	○	○	○	○	○	○	○	○	○	○	○	○	○	○	○	○

Function	Mode	Still Capture																	
		Scene Mode																	
Face Tracking	Off	◆	●	●	●	●	●	●	●	●	●	●	●	●	●	●	●	●	●
	On	x	x	x	x	x	x	x	x	x	x	x	x	x	x	x	x	x	x
Photo Frame	Off	◆	●	●	●	●	●	●	●	●	●	●	●	●	●	●	●	●	●
	Frame 1 ~ 10	○	○	○	○	○	○	○	○	○	○	○	○	○	○	○	○	○	○
Digital Zoom	Off	○	○	○	○	○	○	○	○	○	○	○	○	○	○	○	○	○	○
	On	◆	●	●	●	●	●	●	●	●	●	●	●	●	●	●	●	●	●

◆ : Factory setting ● : Default setting ○ : Available x : Not available.
 ■ : Setting is retained even after mode switch or power off.
 ▨ : Disable function.
 ■ : Set to [OFF] after power off.

Customer care

More information on the complete AgfaPhoto digital camera product range can be found under www.plawa.com / www.plawausa.com

Service & Repair (USA/ Canada):

1-866 475 2605

www.plawausa.com

Support Service (USA/ Canada)

Support-apdc@plawausa.com

Service & Repair Hotline (EU):

00800 752 921 00 (from a landline only)

Service & Support Hotline (Germany):

0900 1000 042 (1.49 Euro/ min. from a German landline only)

Online Service / International contact (Not for USA/ Canada):

support-apdc@plawa.com

Manufactured by

plawa-feinwerktechnik GmbH & Co. KG

Bleichereistraße 18

73066 Uhingen

Germany

AgfaPhoto is used under license of Agfa-Gevaert NV & Co. KG. Agfa-Gevaert NV & Co. KG. does not manufacture this product or provide any product warranty or support. For service, support and warranty information, contact the distributor or manufacturer. Contact: AgfaPhoto Holding GmbH, www.agfaphoto.com

Disposal of Waste Equipment by Users in Private Households in the European Union



This symbol on the product or on its packaging indicates that this product must not be disposed of with your other household waste. Instead, it is your responsibility to dispose of your waste equipment by handing it over to a designated collection point for the recycling of waste electrical and electronic equipment. The separate collection and recycling of your waste equipment at the time of disposal will help to conserve natural resources and ensure that it is recycled in a manner that protects human health and the environment. For more information about where you can drop off your waste equipment for recycling, please contact your local city office, your household waste disposal service or the shop where you purchased the product.

FCC Compliance and Advisory

This device complies with Part 15 of the FCC Rules. Operation is subject to the following two conditions: 1.) this device may not cause harmful interference, and 2.) this device must accept any interference received, including interference that may cause unsatisfactory operation. This equipment has been tested and found to comply with the limits for a Class B peripheral, pursuant to Part 15 of the FCC Rules. These limits are designed to provide reasonable protection against harmful interference in a residential installation. This equipment generates, uses, and can radiate radio frequency energy and, if not installed and used in accordance with the instructions, may cause harmful interference to radio communication. However, there is no guarantee that interference will not occur in a particular installation. If this equipment does cause harmful interference to radio or television reception, which can be determined by turning the equipment off and on, the user is encouraged to try to correct the interference by one or more of the following measures.

- Reorient or relocate the receiving antenna.
- Increase the separation between the equipment and receiver.
- Connect the equipment to an outlet on a circuit different from that to which the receiver is connected.
- Consult the dealer or an experienced radio/TV technician for help.

Any changes or modifications not expressly approved by the party responsible for compliance could void the user's authority to operate the equipment. When shielded interface cables have been provided with the product or when specified additional components or accessories have elsewhere been designated to be used with the installation of the product, they must be used in

order to ensure compliance with FCC regulations.

Declaration of Conformity

We herewith confirm the following designated product: AgfaPhoto digital camera DC-833s has been tested and found to comply with the requirements set up in the council directive on the approximation of the law of members' states relating to the EMC Directive 2004/108/EC. For the evaluation regarding to the electromagnet compatibility, the following standards were applied:

EN 55022: 2006, Class B EN 55024: 1998 + A1: 2001 + A2: 2003

IEC 61000-4-2: 1995+A1: 1998+A2: 2000

IEC 61000-4-3: 2002+A1: 2002

IEC 61000-4-4: 2004

IEC 61000-4-6: 1996+A1:2000

IEC 61000-4-8: 1993+A1: 2000

The device is marked with CE Logo.